

# The Power of 5G

## When every second counts

November 2023

# Speakers



**Graham Everington**

**Regional Sales Manager Blue Light,  
UKI**

---

[graham.everington@cradlepoint.com](mailto:graham.everington@cradlepoint.com)



**Paul Pearson**

**Director, Sales Engineering**

---

[ppearson@cradlepoint.com](mailto:ppearson@cradlepoint.com)



# Agenda

- **The Connectivity Journey**
  - The History of Communications
  - The Journey of the G
- **Cradlepoint 5G – Use Cases**
  - Vehicles, Stations, and Beyond
- **The Future**

# The History of Communication

Where we've come from?

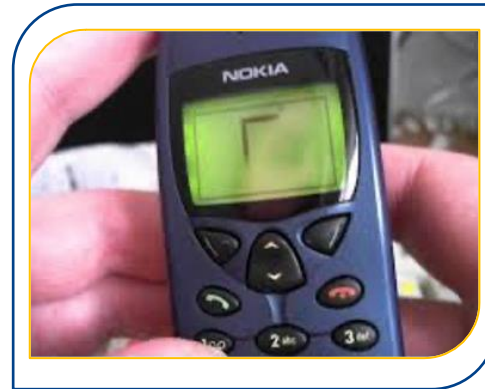
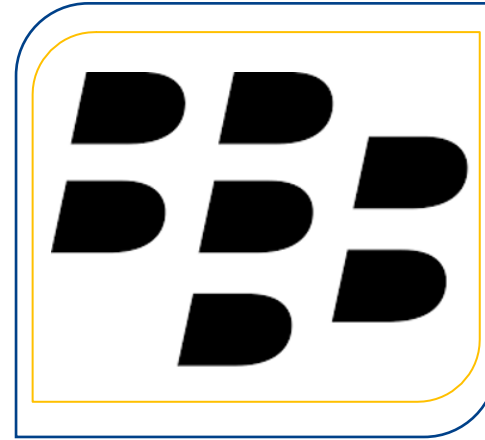

# And then....Wireless Cellular



## The Journey of the G's

# Connecting Vehicles

## Police

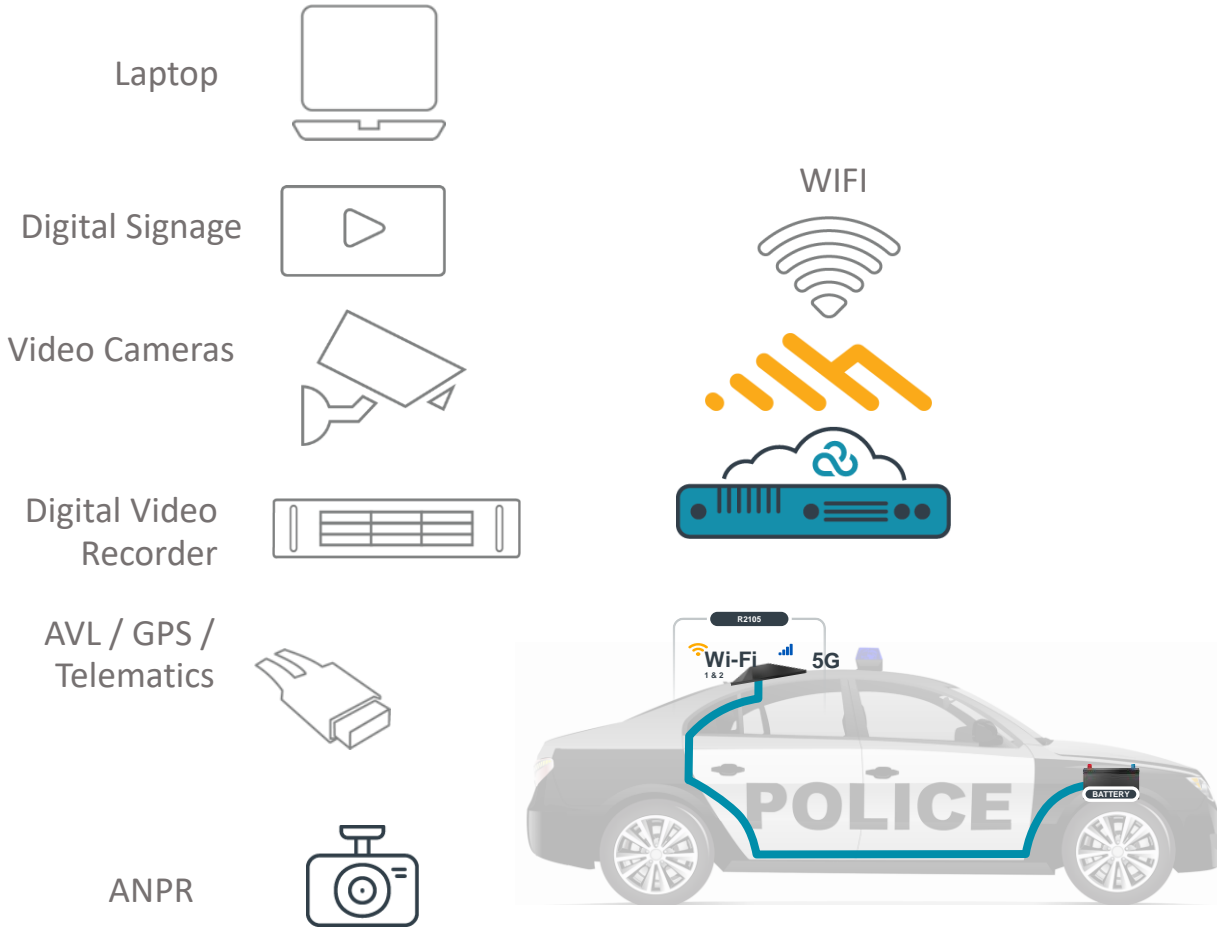

### Problem

Vehicles need to be fully connected for efficiency, safety and responsiveness

### Cause

Lack of, or inefficient real time data communications to the fleet

### Solution

Cradlepoint multi SIM, 4G Mobile routers with vehicle integration

### Benefit

High availability and simplified operations  
Mobile becomes another network node

# PSTN Going Away, Let's Talk Station-End

## Station End

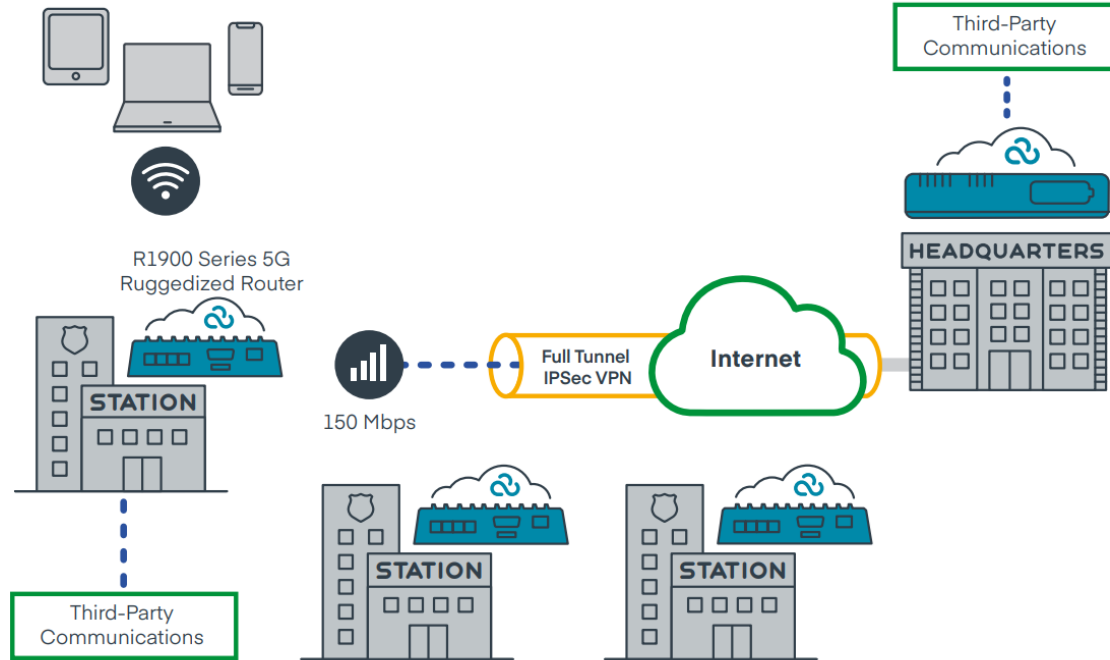

# What About Backup, Let's Talk Fail-Over

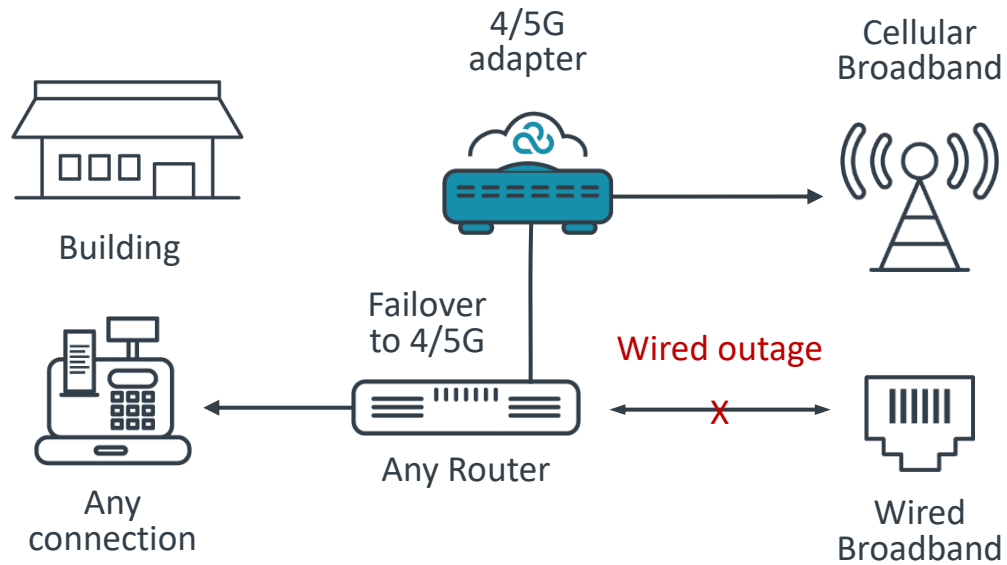

## Scenario

Secondary bearer in Stations

## Cause

PSTN used as secondary connection, cost of replacement through fibre

## Solution

Cloud managed Cradlepoint Branch Continuity solution, 5G ESN accredited device for future proofing

## Benefit

Peace of mind, network diversity & continuity for mission critical operational needs



# Pop Up Major Incident Rooms

## Fire and Rescue Service

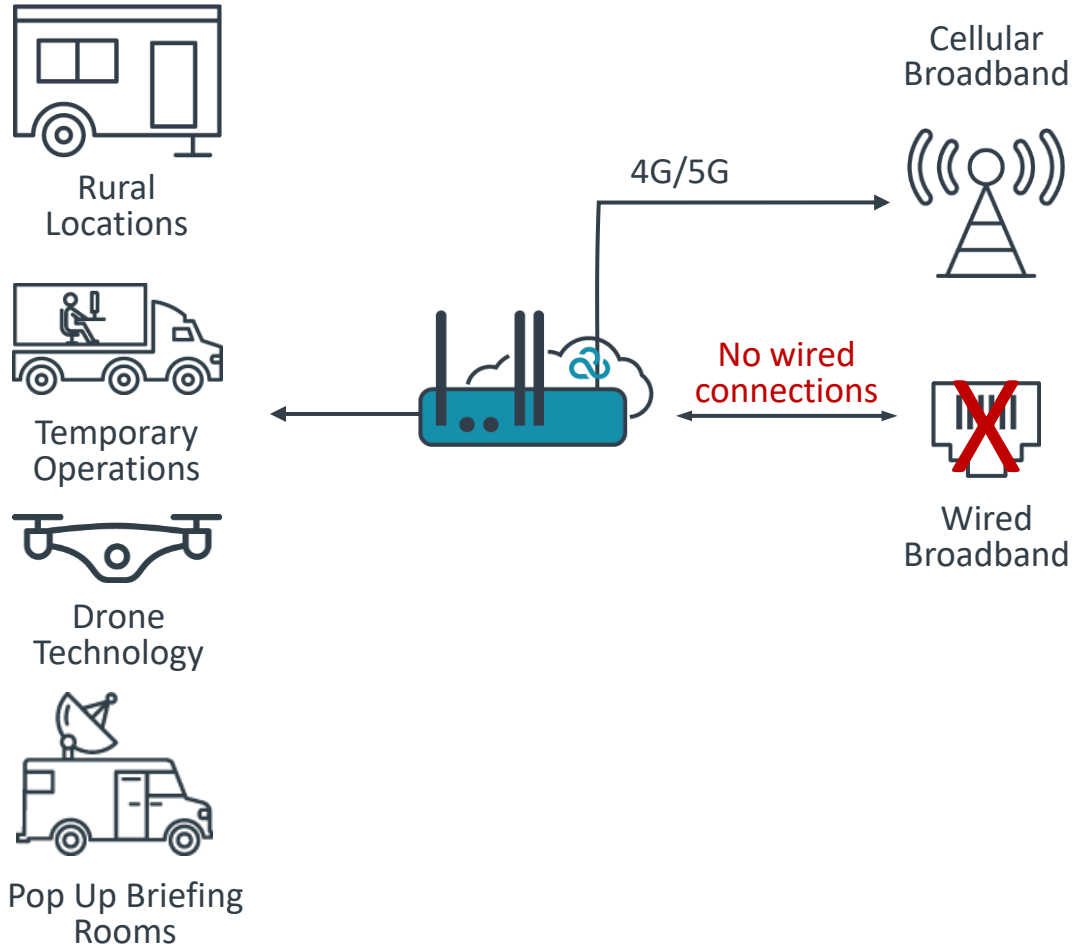

### Scenario

Pop up briefing rooms and operations centres

### Cause

Immediate connectivity required for emergency situations and drone team

### Solution

Cloud managed Cradlepoint Branch or Mobile 4G router on one or more mobile networks, provided in pelicase with battery and antenna

### Benefit

Location independence, ease of set up, ruggedized for fire scene & carrier diversity

# Meet the **Cradlepoint Hardware** Family

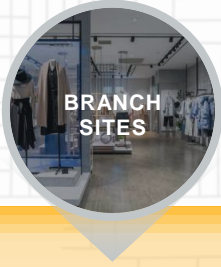

BRANCH  
SITES



**E3000 Series Enterprise Router (5G/4G)**



**E300 Series Enterprise Router (5G/4G)**



**W2005 Series 5G Wideband Adapter**



**W1855 Series 5G Wideband Adapter**



**W1850 Series 5G Wideband Adapter**



**L950 Series LTE Adapter**



**CBA550 Series LTE Adapter**

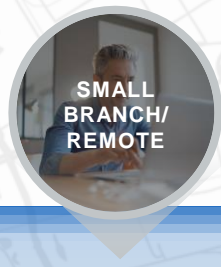

SMALL  
BRANCH/  
REMOTE



**E102 Series Enterprise Router**



PRIVATE  
CELLULAR  
NETWORKING



**A2400 Indoor Cellular Access Point**



**A2405 Outdoor Cellular Access Point**

COMING SOON



IOT



**IBR200 Series Router**



**IBR600C Series Router**



**S700 Series Semi-Ruggedized Router**



**IBR900 Series Ruggedized Router**



**R920 Series Ruggedized Router**



**R2100 Series 5G Ruggedized Router**



IN-VEHICLE



**IBR1700 Series Ruggedized Router**



**R1900 Series 5G Ruggedized Router**

# What is NCX?

Managed by  

Customers subscribe to one or more service

Secure Connectivity

SDWAN

Zero Trust Network Access

On Premise VM

Public Cloud VM  
(AWS/Azure)

Delivered as software, NetCloud Service Gateway, NCSG

Tunnel Aggregation  
Policy Enforcement  
Flow level visibility  
(application engine)

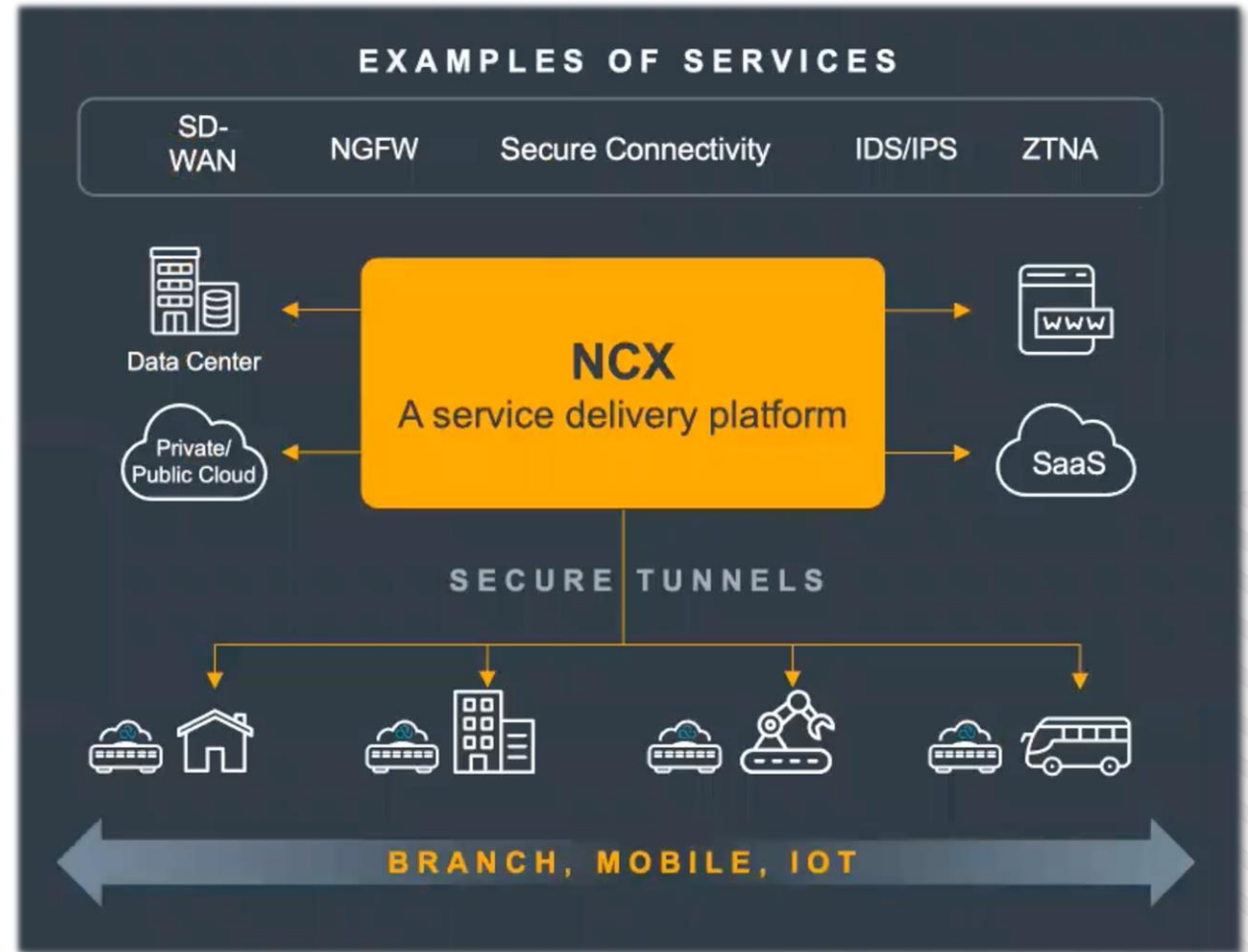

# NetCloud Exchange



A secure network service that drastically reduces attack surface and unlocks operational agility



A network service that orchestrates traffic flows for optimal quality of experience and reliability

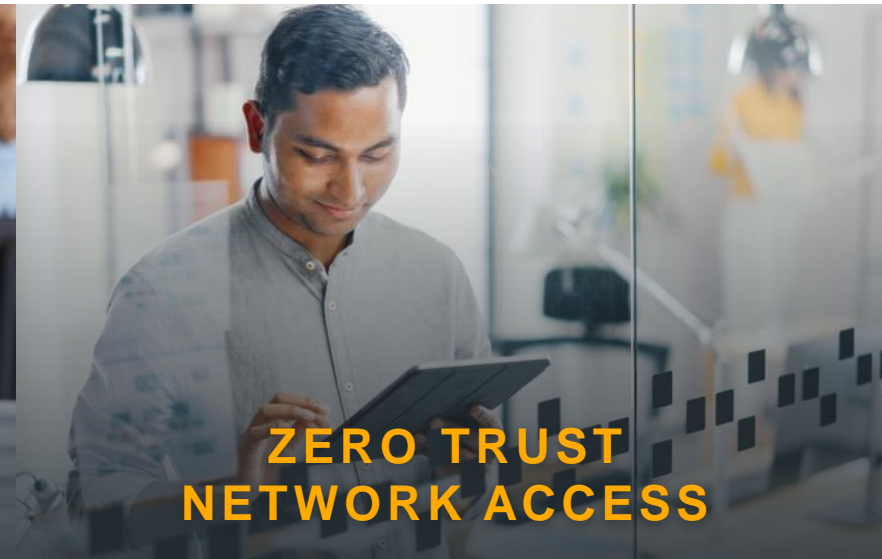

A security service that creates a logical access boundary around private resources through identity and context-based parameters

# Extending WiFi Capabilities



Any handheld device can access any vehicle SSID and retain the same IP address from the LAN/WAN. E.g. staff1 will retain IP address 10.0.0.5 regardless of roaming

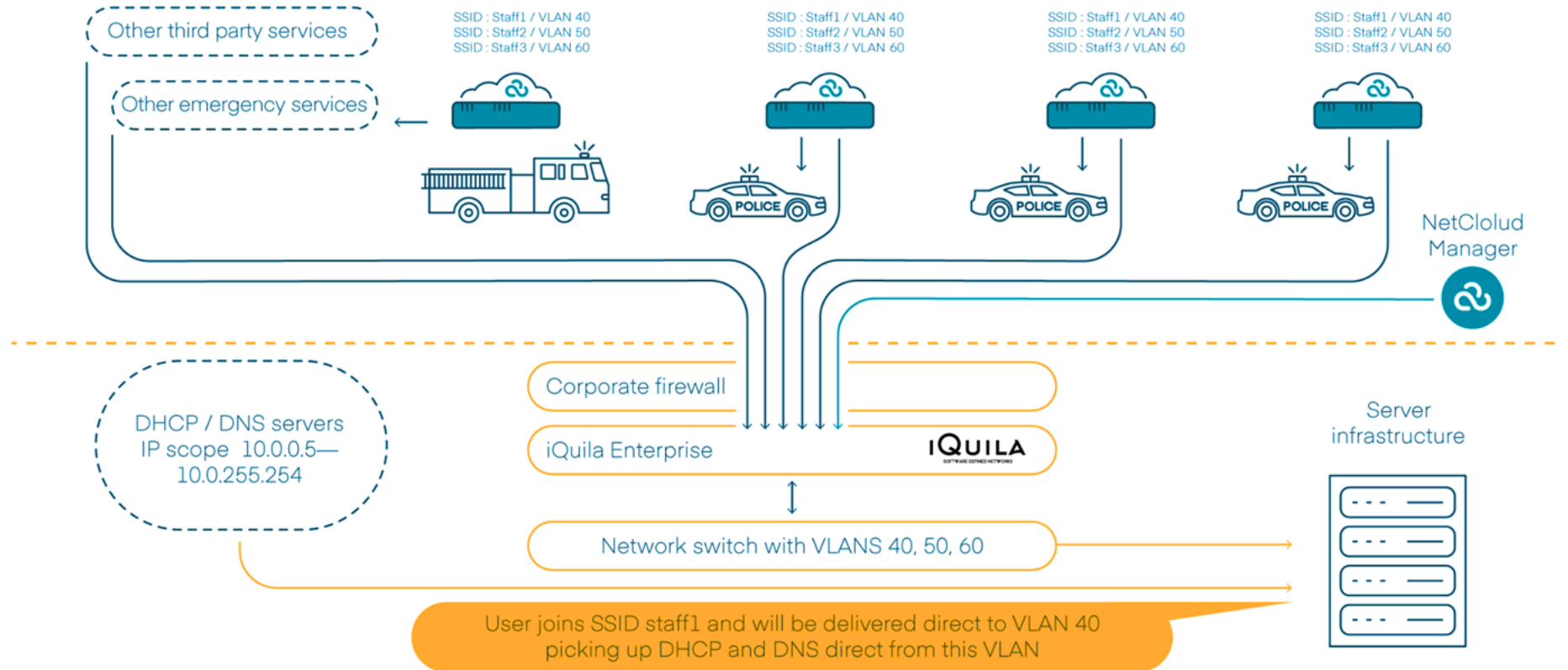

Layer 2 VEN connection

NetCloud connection



# Thank You

Graham Everington

[graham.everington@cradlepoint.com](mailto:graham.everington@cradlepoint.com)

07484 101247

